

LASET NEW

Art.-Nr.

406 081
406 082
406 083
406 084
406 085

800
433
1850
mm

1/10
vD
15-2025

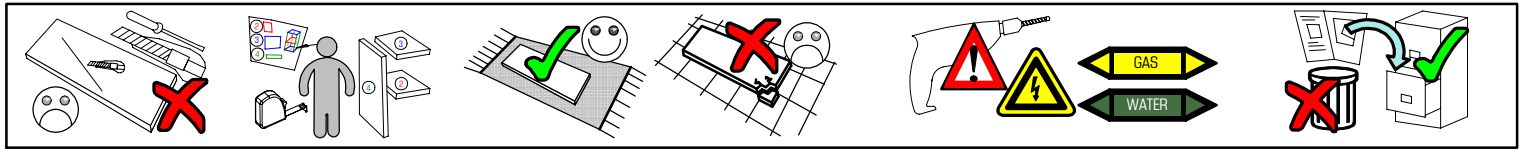
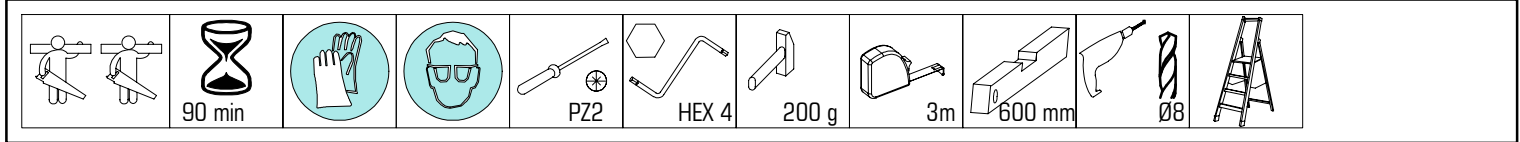

ID	ID	Dimensions	Quantity	Ratio
22056	②	830*410*16	1x	1/2
22057	③	766*410*16	1x	1/2
22058	④	718*410*16	1x	1/2
22059	⑤	766*96*16	2x	2/2
22060	⑥	830*410*16	1x	1/2
22061	⑦	800*430*22	1x	1/2
22062	⑧	375*400*16	1x	1/2
22063	⑨	742*396*3	2x	1/2
22064	⑩	728*396*16	1x	1/2
22065	⑪	396*240*16	3x	2/2
19738	⑫	350*100*16	3x	2/2
22066	⑬	317*100*16	3x	1/2
19740	⑭	350*100*16	3x	2/2
22067	⑮	347*356*3	3x	1/2
22068	⑯	999*302*16	1x	2/2
22069	⑰	999*302*16	1x	2/2
22070	⑱	766*302*16	2x	2/2
22071	⑲	766*292*16	1x	2/2
22072	⑳	396*396*16	1x	1/2
22073	㉑	396*396*16	1x	1/2
22074	㉒	390*794*3	1x	1/2
22075	㉓	794*615*3	1x	2/2

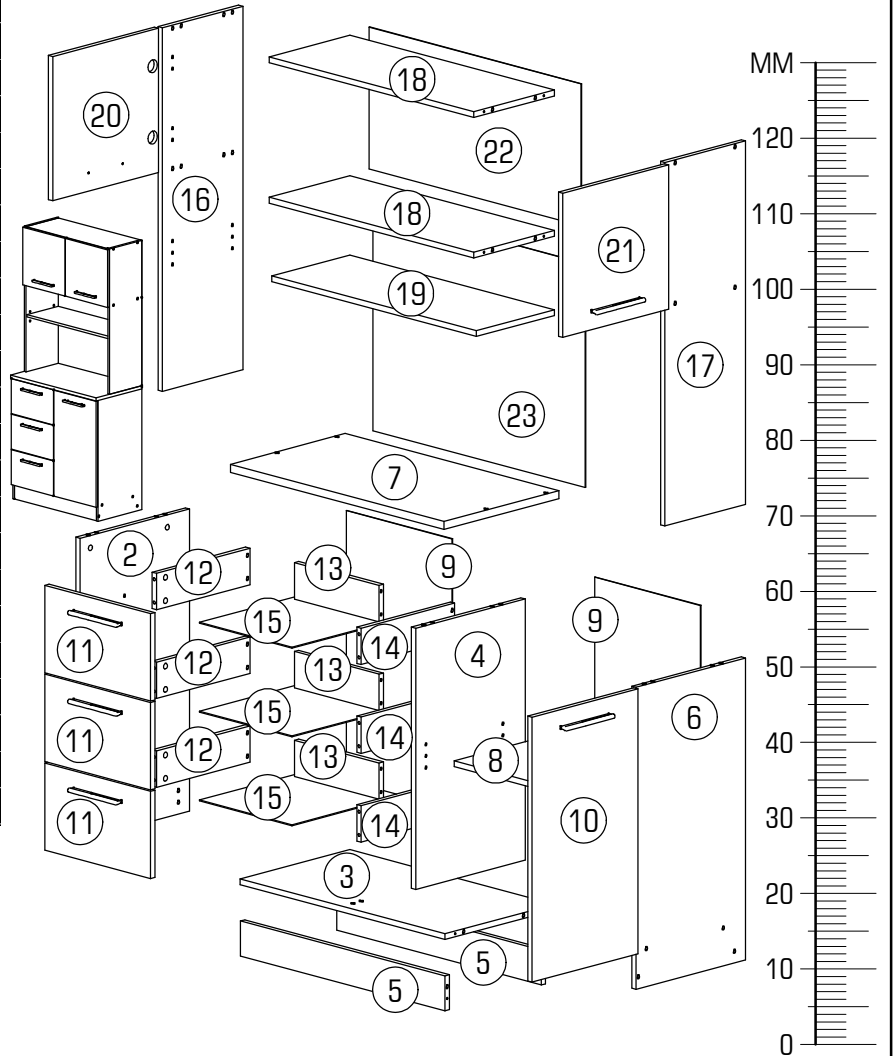

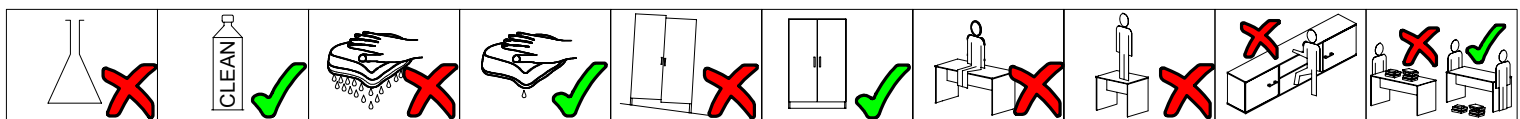

	27000,00		22300,00		70013,01		70021,01		30091,00		31103,00
A	12x	B	24x	C	30x	D	18x	E	18x	F	6x
	22244,01		22255,00		24101,00		21102,00		22236,00		22243,00
J	11x	K	1x	L	1x	M	50x	N	21x	P	36x
	24008,00		35101,01		32029,00		33009,02		33009,02		36002,07
S	21x	T	8x	V	6x	W1	3x	W2	3x	Y1	6x
	22280,00		22705,00		22305,02		22305,02		22305,02		22305,02
Q	12x	R	18x	Z	4x						



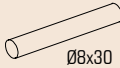
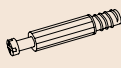
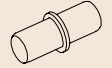
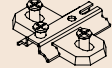

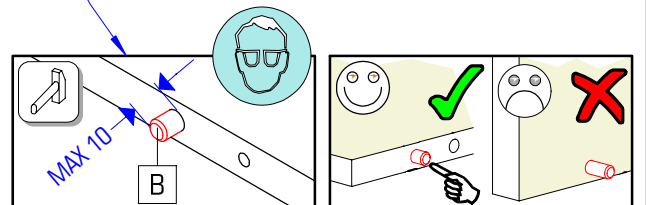
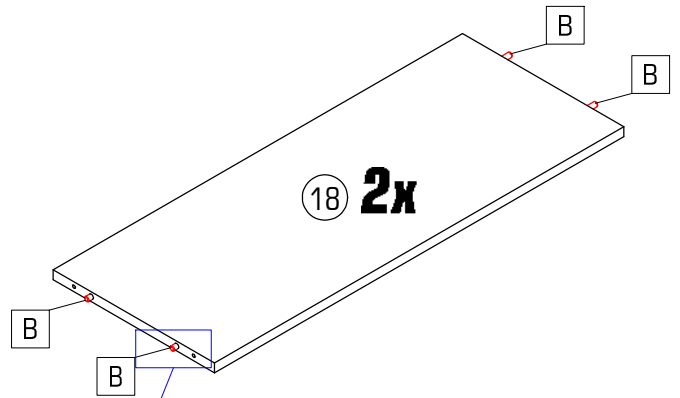
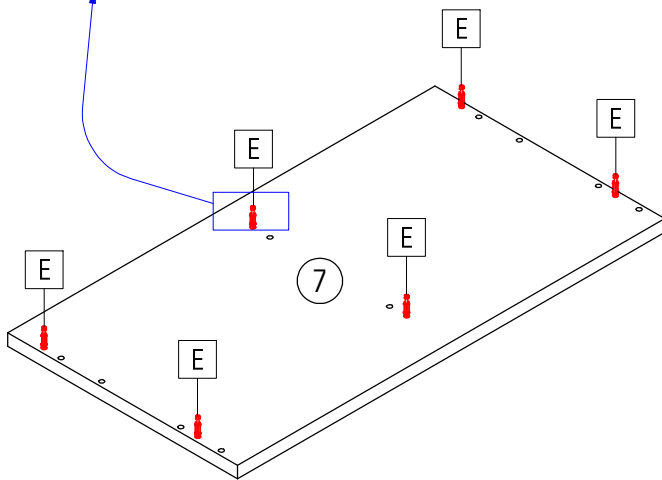
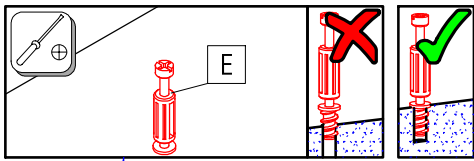
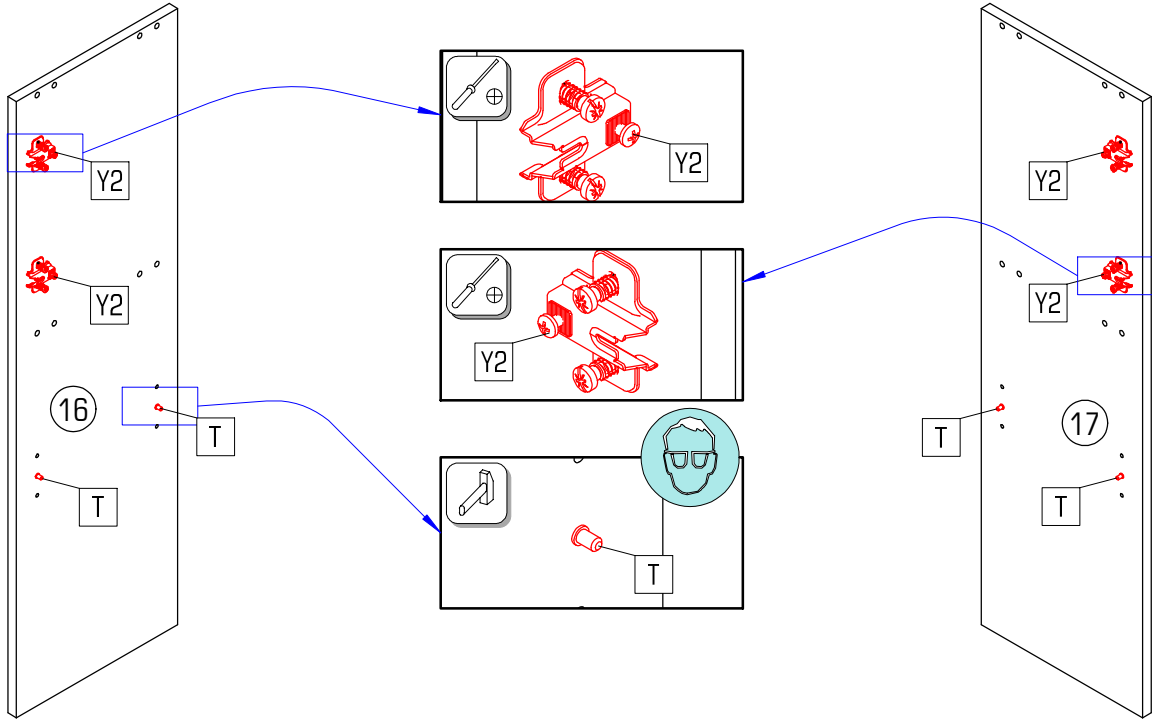
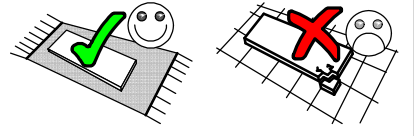
2/10 LASET NEW

			
B	8x	E	6x
		T	4x
		Y2	4x

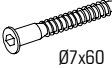

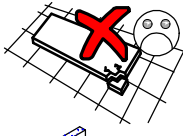
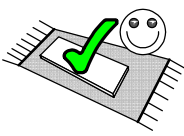
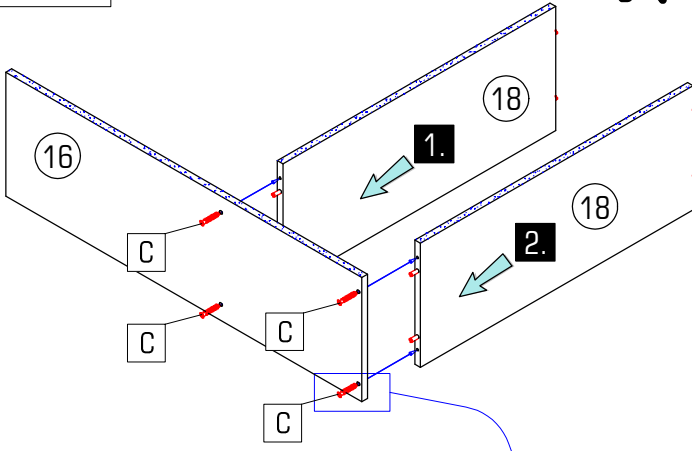
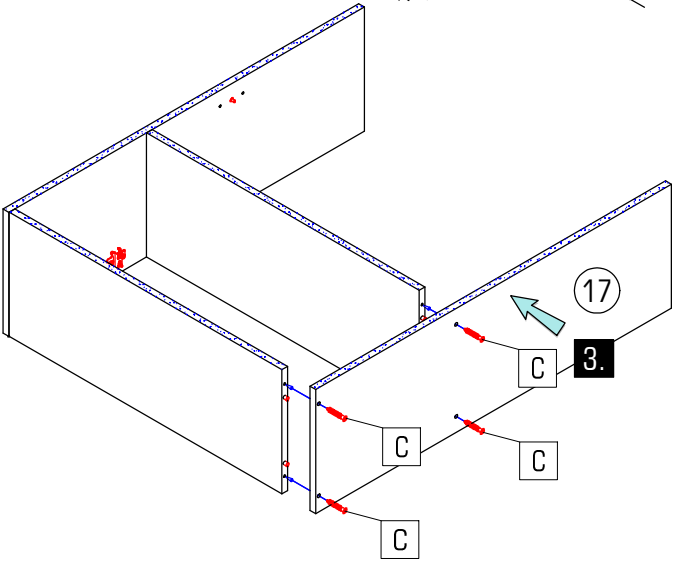
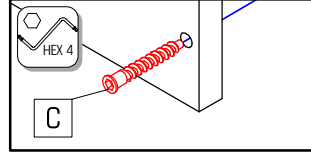

	Ø7x50
C	8x
	Ø7x60
Z	4x

M 1:1

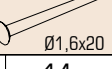
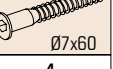





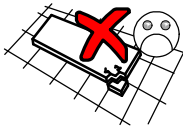
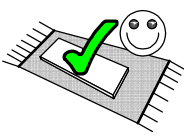
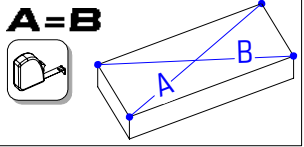
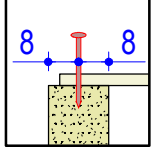
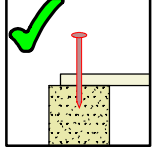
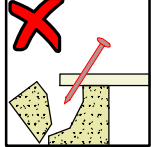

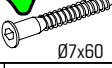
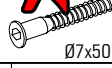

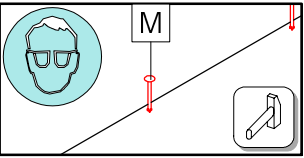
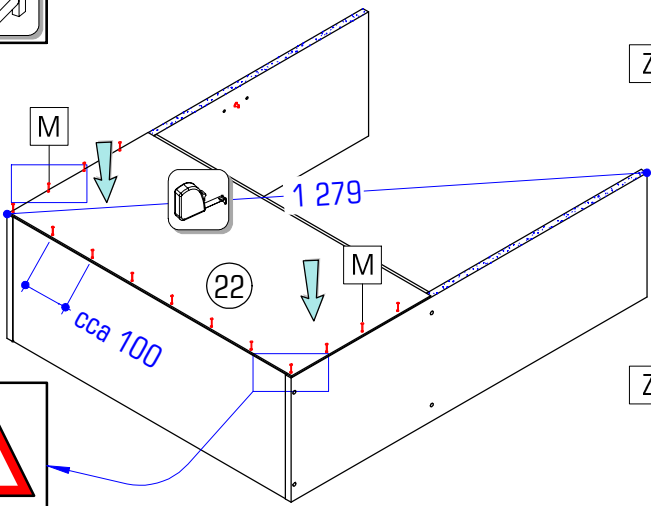
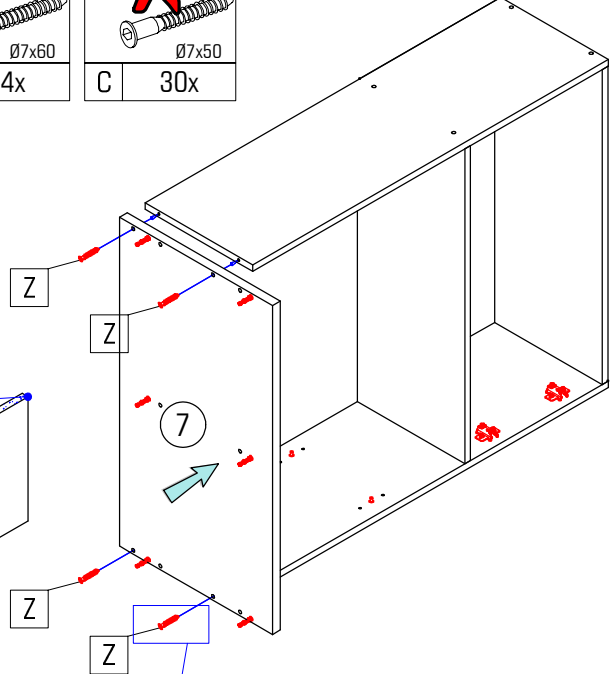
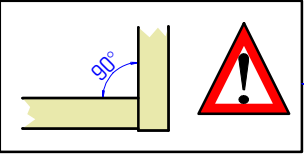
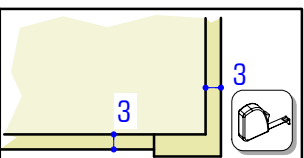
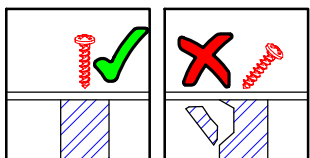
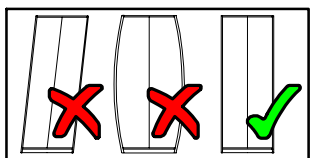
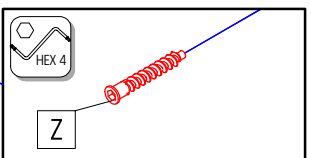
	Ø1,6x20		Ø7x60
M	14x	Z	4x



A=B







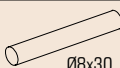



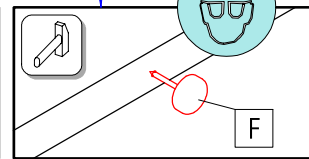
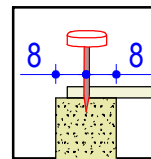
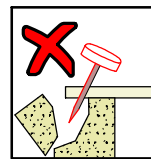
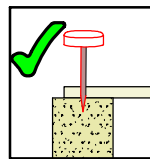
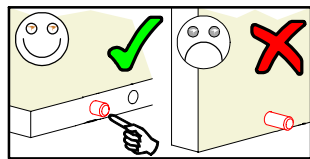
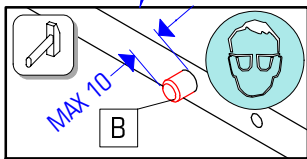
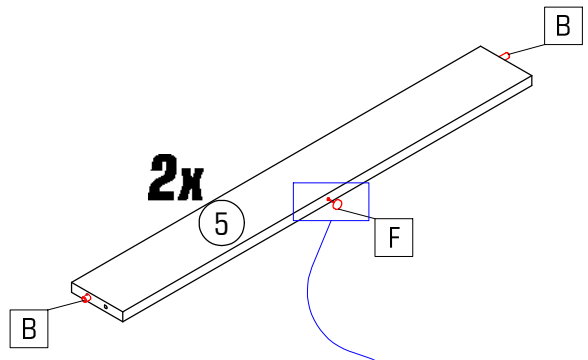
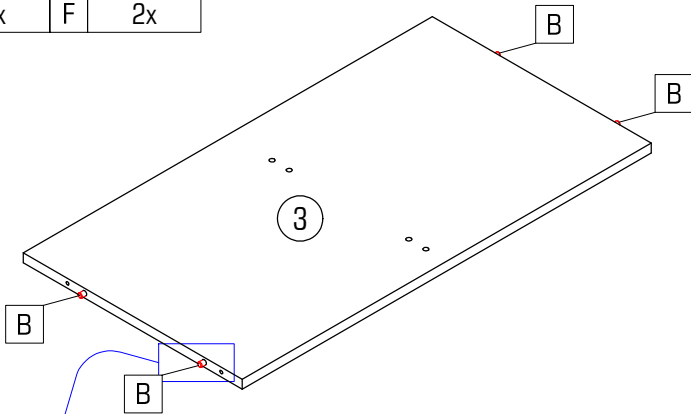







	Ø7x60		Ø7x50
Z	4x	C	30x

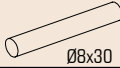

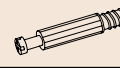





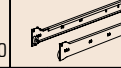

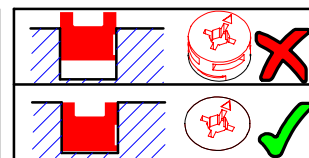
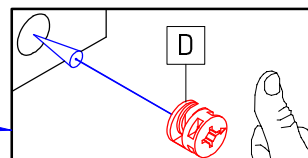
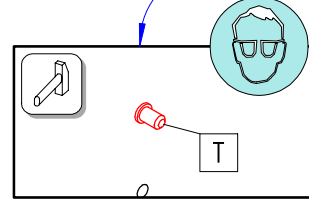
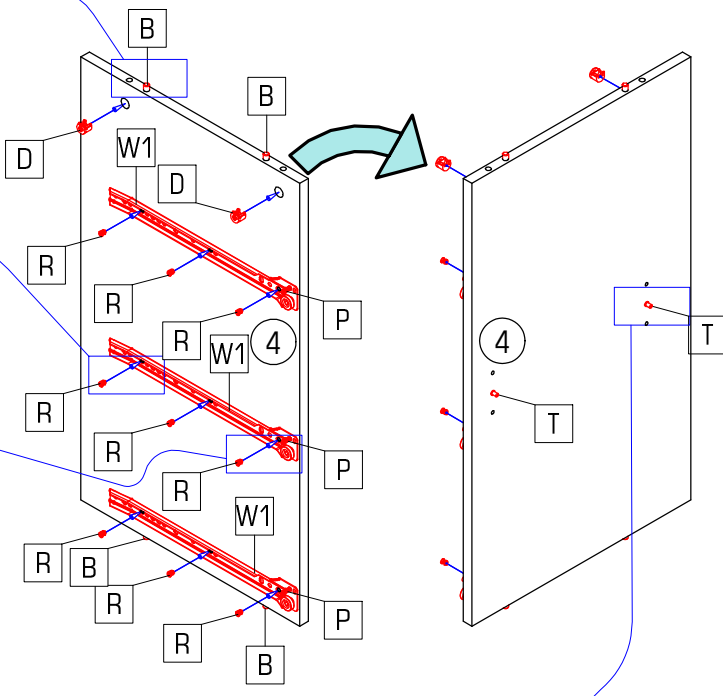
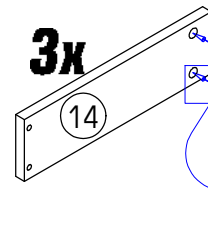
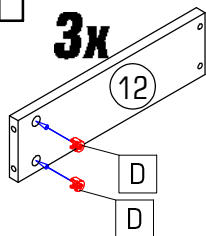
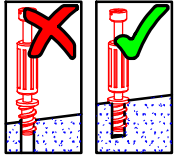
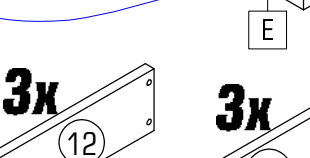
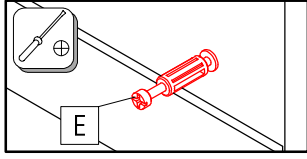
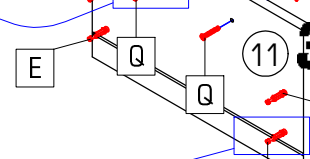
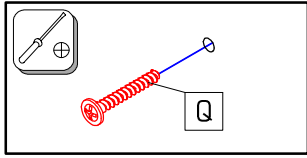
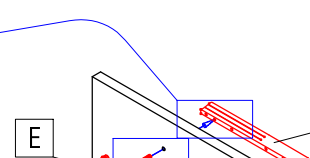
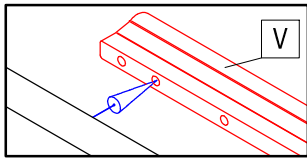
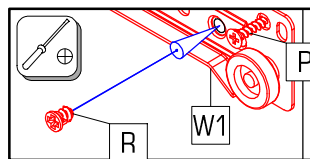
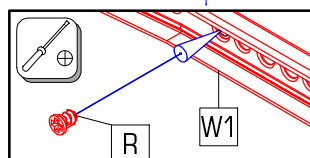
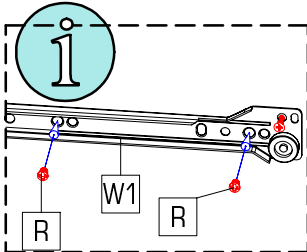
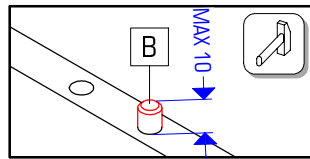
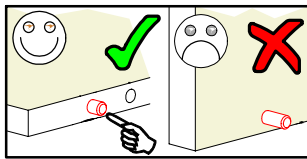



4/10 LASET NEW

	
B 8x	F 2x

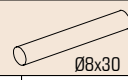

								
B 4x	D 14x	E 12x	P 3x	Q 6x	R 9x	T 2x	V 3x	W1 3x

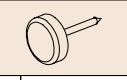
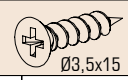

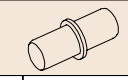
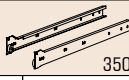
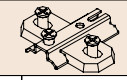
															
B	4x	D	4x	F	4x	P	3x	R	9x	T	2x	W1	3x	Y2	2x

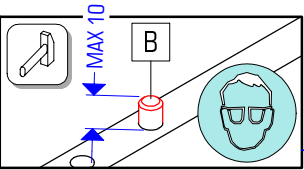
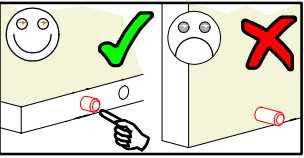
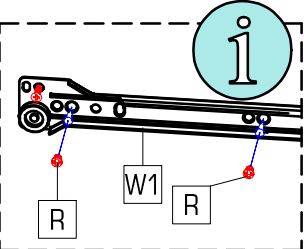
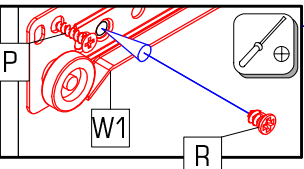

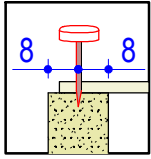
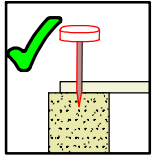
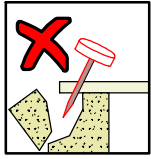

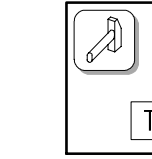
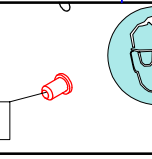

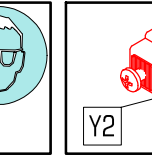
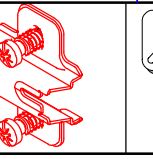

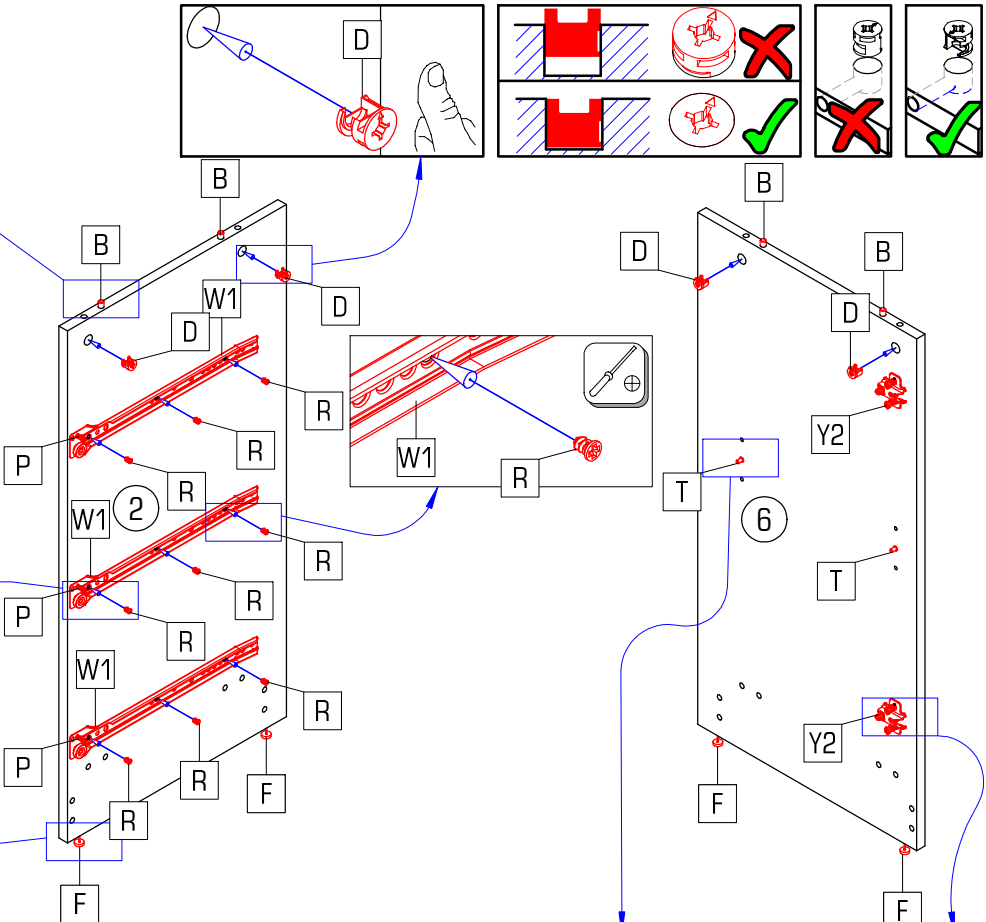

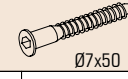





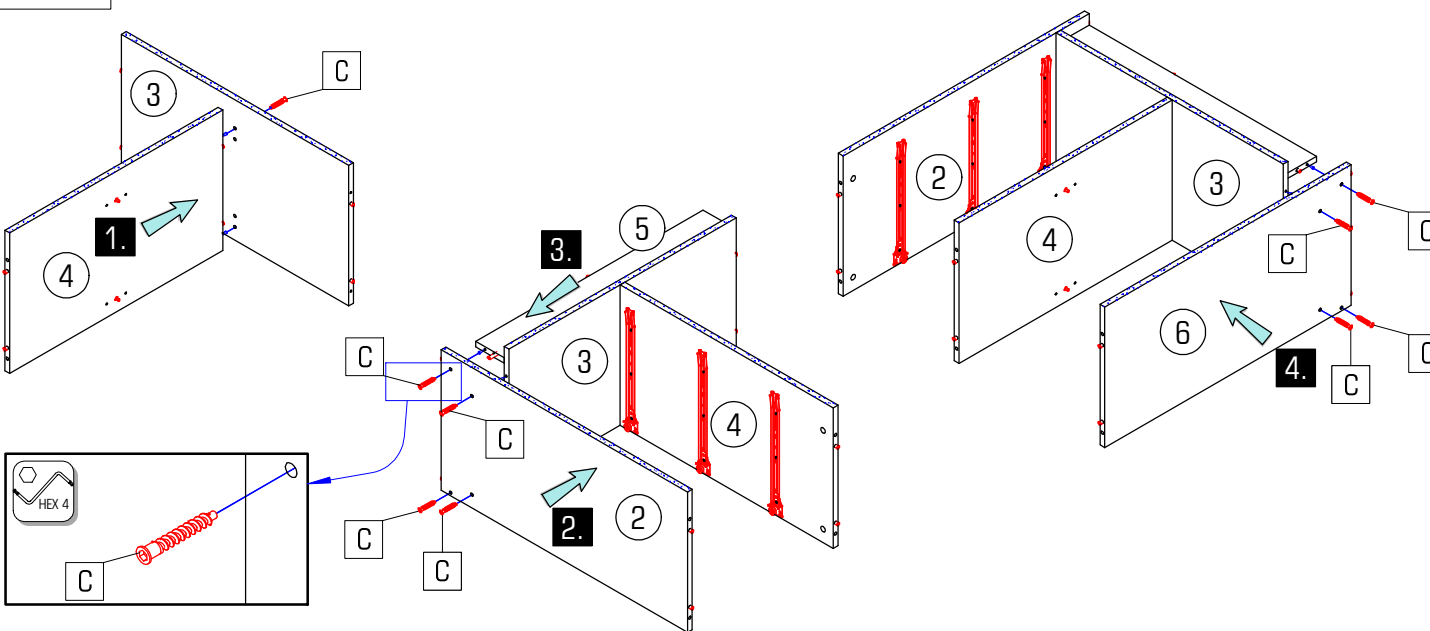

C

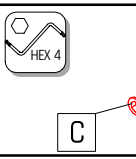

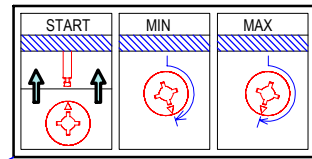
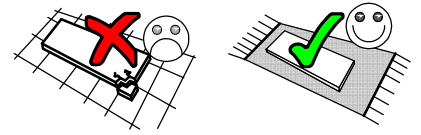
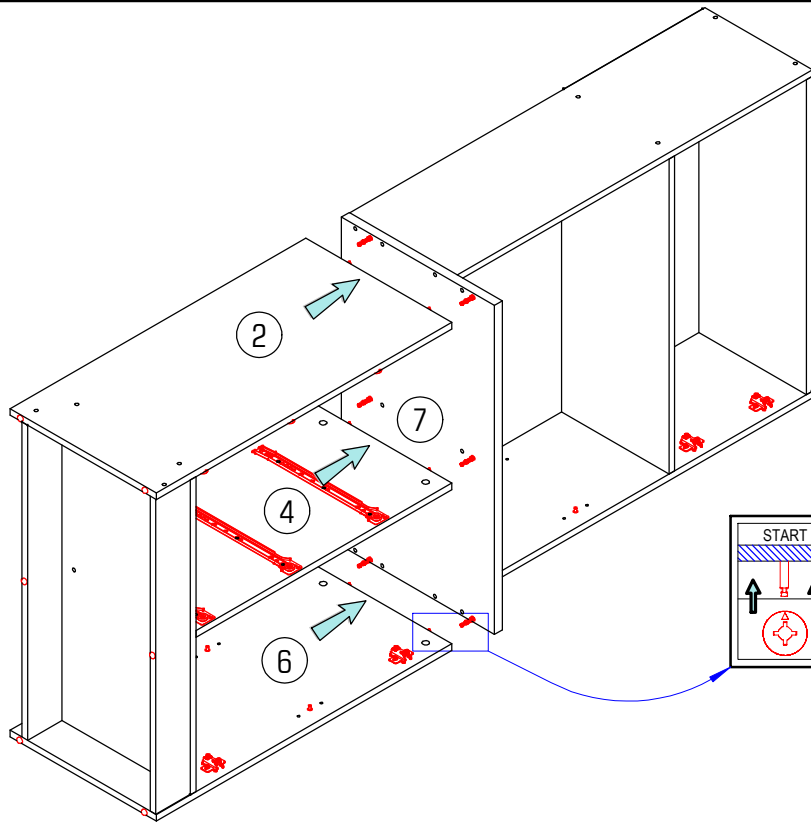

6/10 LASET NEW



G 16x	M 34x	N 21x	S 21x
	Ø1,6x20	Ø2,5x16	3,0

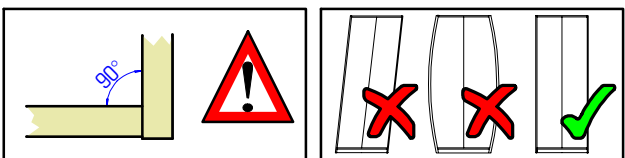
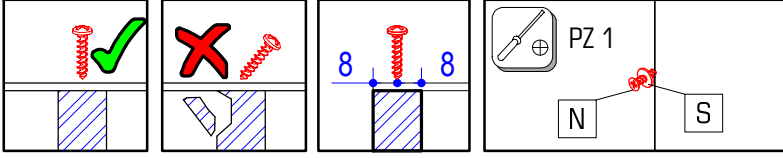
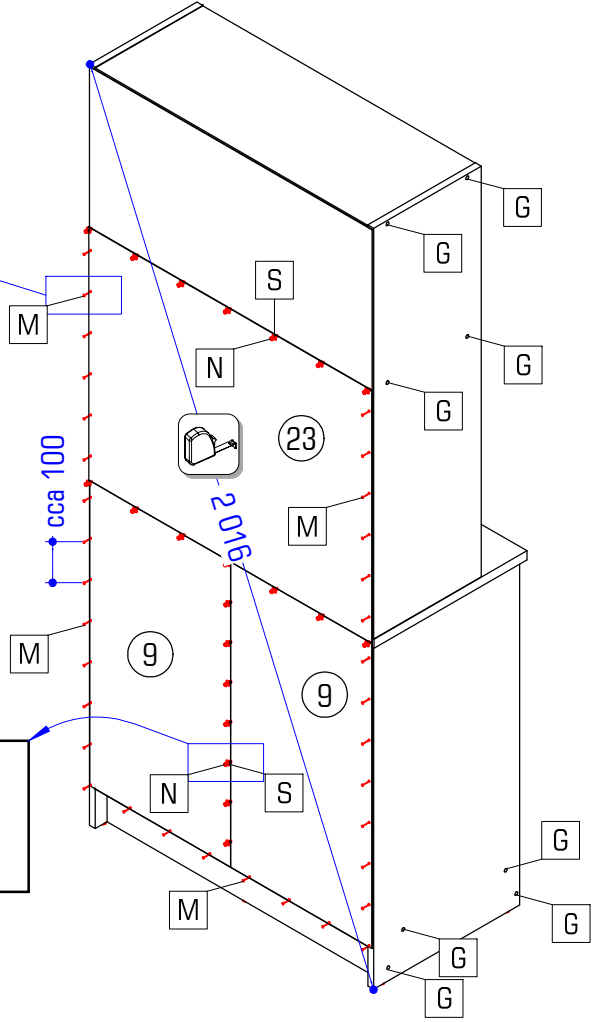
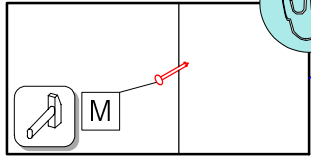
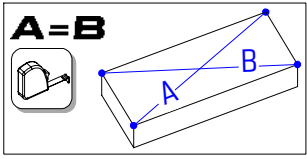
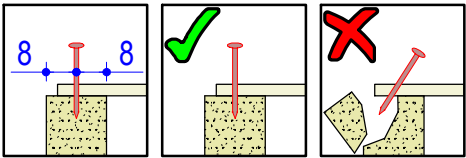

H 1x	J 2x	K 1x	L 1x

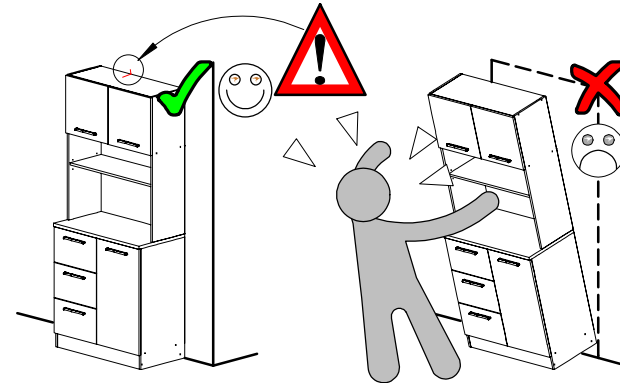
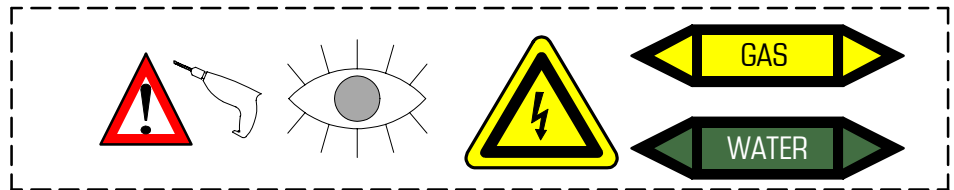
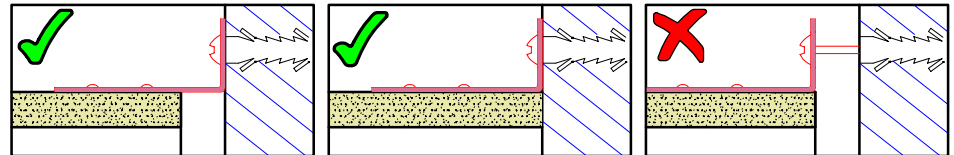
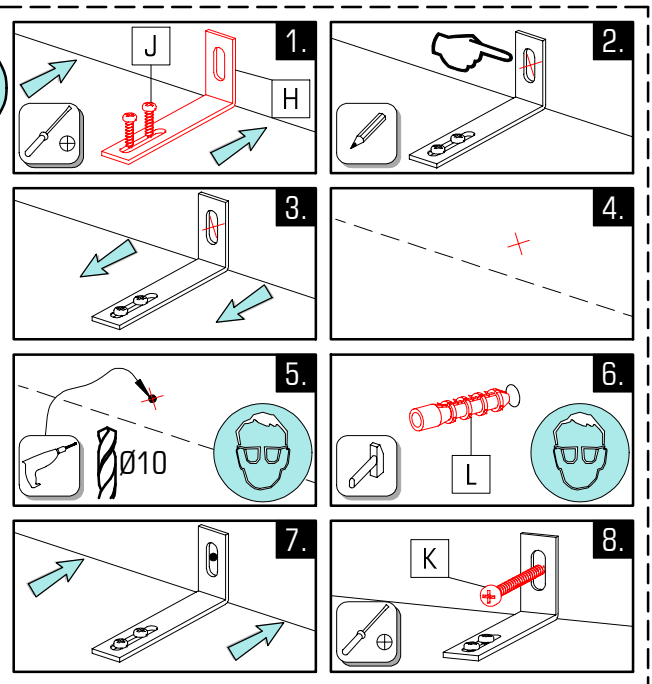
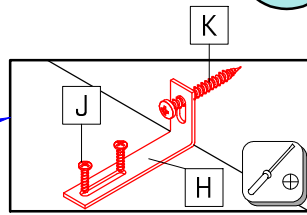
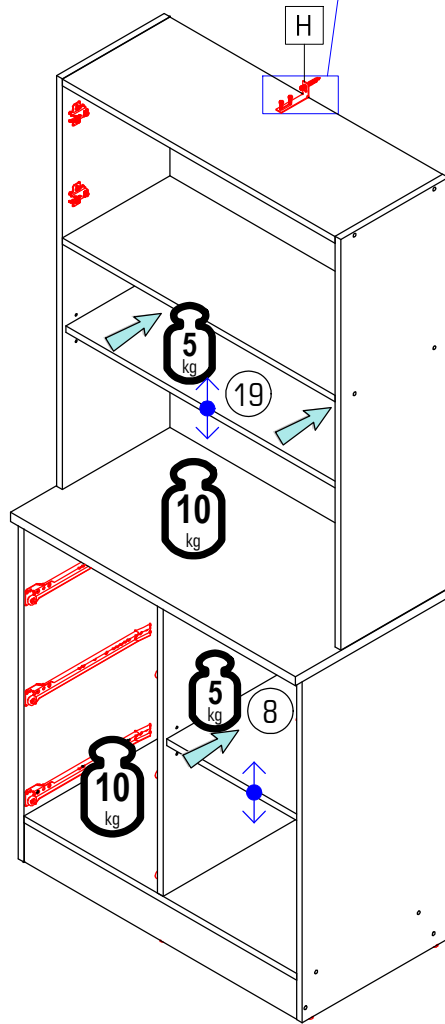
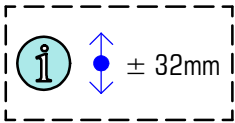

SK	VÝSTRAHA
CZ	VAROVÁNÍ
HR	UPOZORENIE
DE	WARNUNG
HU	FIGYELEM
PL	OSTRZEŻENIE
RO	AVERTIZARE
EN	WARNING
SI	OPOZORILLO

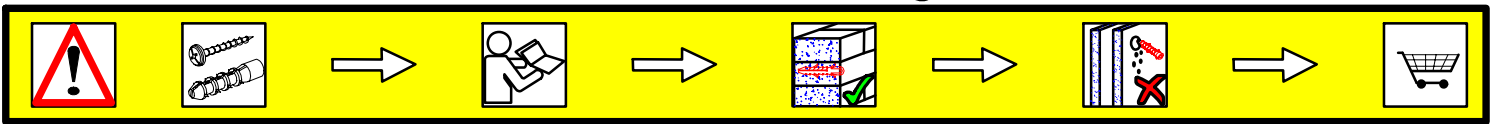

PL Uwaga! Ścianę należy sprawdzić przed montażem. Dołączone uniwersalne kolki rozporowe są odpowiednie tylko do stosowania w mocnych murach, takich jak beton lub cegła. Nie rób z pomocą kółków oporowych murowanych, takich jak pustak, lekka kostka, powierzchnie takie jak płyty gipsowo-kartonowe lub inne systemy ram. Jeśli dotyczy, muszą to być określone kolki rozporowe być użyty! Są one dostępne w specjalistycznym sklepie niezgodność producent / sprzedawca lub importer nie ponoszą odpowiedzialności.

RO Prudență! Zidul trebuie examinat înainte de asamblare prizele de perete sunt adecvatenumai pentru utilizarea în zidurile fermă, cum ar fi betonul bloc sau cărămidă. Nu folosiți zidăria zidurilor de perete, cum ar fi cărămida goală, blocul ușor, suprafețe cum ar fi gips-carton sau altă încădrare sisteme. Dacă este cazul, trebuie folosite anumite prize de perete! Acestea sunt disponibile la un magazin specializat (magazin de hardware) . În caz de nerespectare, producătorul / vânzătorul cu amănuntul sau importatorul nu își asumă răspunderea.

SI Pozor! Pred montažo preverite stanje stene. Priloženi univerzalni mozniki so izključno samo za uporabo na čvrstem zidovju, kot sta beton in opeka. Stenski mozniki se ne smejo uporabljati pri zidovju kot so votlina opeke, zidaki za lahko gradnjo, mavčne plošče ali druge okvirne gradnje. Pri teh zidovjih morate v danih primerih uporabljati posebne moznike. Ti so na voljo v specializiranih trgovinah (trgovinah z gradbenim materialom) Pri upoštevanju se s strani proizvajalca/trgovca in uvoznika ne prevzame jamstvo.

DE Achtung! Die Wandbeschaffenheit ist vor der Montage unbedingt zu prüfen. Die beigelegten Universaldübel sind ausschließlich nur zur Verwendung für festes Mauerwerk wie Beton/Ziegel. Die Mauerdübel dürfen nicht bei Mauerwerk wie Hohlraumziegel, Leichtbausteinen, Gipskarton platte oder anderer Rahmenbauweise verwendet werden. Bei diesen Mauerwerken sind gegebenenfalls Spezialdübel zu verwenden! Diese sind in einem Fachgeschäft erhältlich. Bei Nichterhaltung wird seitens Produzenten/Händler und Importeur keine Haftung übernommen.

HR Pažnja! Prije montaže obvezno provjerite svojstvo zida. Priložene univerzalne tiplje namijenjene su isključivo za masivne zidove od betona/opeke. Tiplje za masivne zidove ne smiju se koristiti za zidove kao npr šupljina opeka laki sastavni elementi, gips-kartonske ploče ili drugi modularni načini gradnje. Za te zidove potrebne su eventualno specijalne tiplje! Iste su dostupne u specializiranim trgovinama građevinskim materijalom. U slučaju nepridržavanja prethodno navedenih napomena, proizvođač/trgovac i uvoznik ne preuzimaju odgovornost!

HU Vigyázat! Szerelés előtt a falfelületet feltétlenül vizsgálja meg. A mellékelt univerzális tiplje kizárólag stabil falazathoz használható mint például beton/tégla. A fali tiplje nem használható könnyű építőkövekhez, üreg tégla, gipszkarton lapokhoz vagy más fávázás építményekhez. Ezekhez a falfelületekhez csak speciális tiplik használhatóak, melyek szaküzletekben (barkácsruházakban) beszerezhetőek. Fentiek figyelmen kívül hagyása esetén a gyártó/kereskedő vagy forgalmazó nem vállal felelősséget.

EN Caution! The wall must be examined before assembly. The included universal wall plugs are only suitable for using in firm masonry such as concrete block or brick. Do not use the wall plugs masonry such as hollow brick, lightweight block, surfaces such as gypsum plasterboard or other framing systems. If applicable, particular wall plugs must be used! These are available at a specialised store (hardware store). In case of non-compliance, the manufacturer/retailer or importer do not assume liability.





CZ Upozornění! Před montáží je nutné zkontrolovat stav stěny. Přiložené univerzální hmoždinky jsou určeny pouze k použití pro pevné zdivo jako beton/cihly. Hmoždinky do zdi se nesmí používat u dutinová cihla, zdiva jako pórovitý stavební kámen, sádrokartónová deska nebo jiný měkký materiál. U těchto zdiv jsou nutné použít speciální hmoždinky! Jsou k dostání v speciálních prodejnách se stavebním materiálem. Při nedodržení těchto pokynů výrobce/prodejce a dovozce neručí za způsobené škody.

SK Upozornenie! Pevnosť steny sa musí pred montážou bezpodmienečne skontrolovať. Priložené univerzálne hmoždinky používajte jedine pre pevné murivo ako je betón/tehla. Hmoždinky sa nesmú používať v prípade ľahkého stavebného muriva, dutá tehla, Sádorkartónová doska, alebo iných konštrukcií rámu. U týchto stien je nutné použiť špeciálne hmoždinky! Tieto je možné dostať v špeciálnych predajniach so stavebným materiálom. Pri nedodržaní pokynov nepreberajú výrobcovia/predajci a dodávateľia zodpovednosť za vzniknuté škody.

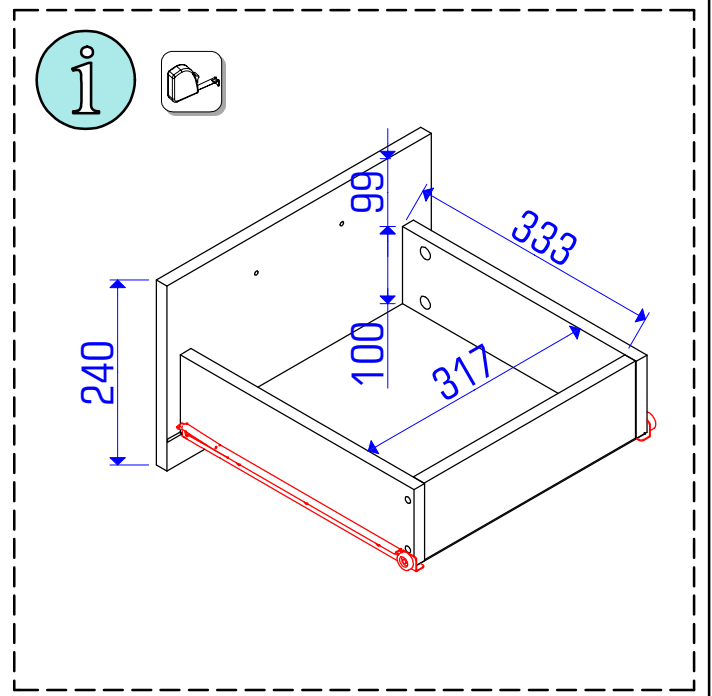
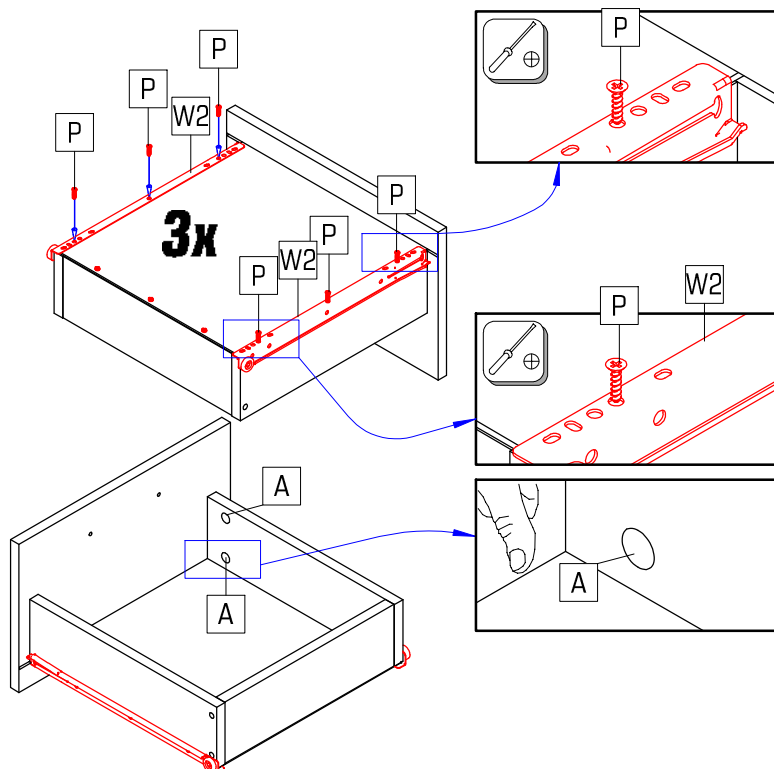
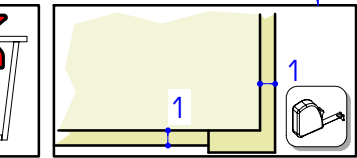
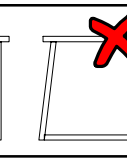
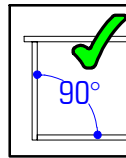
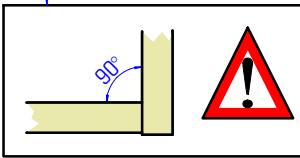
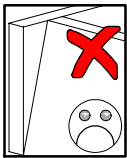
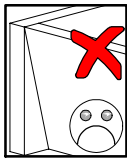
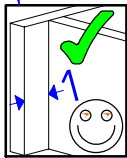
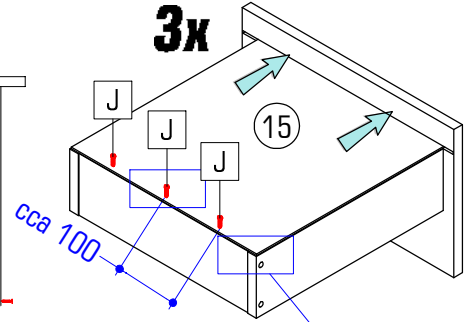
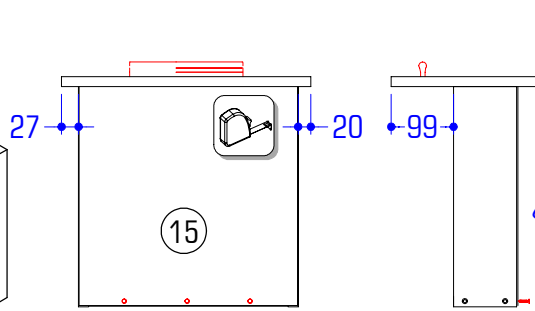
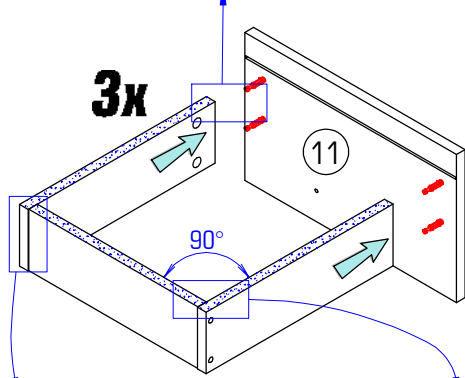
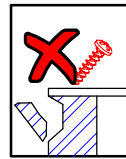
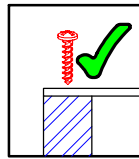
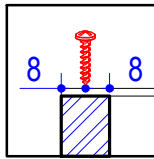
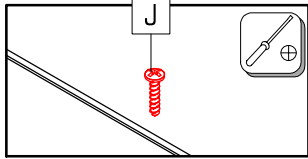
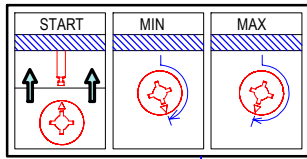
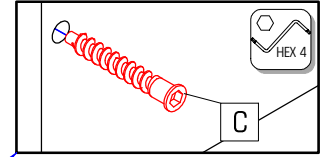
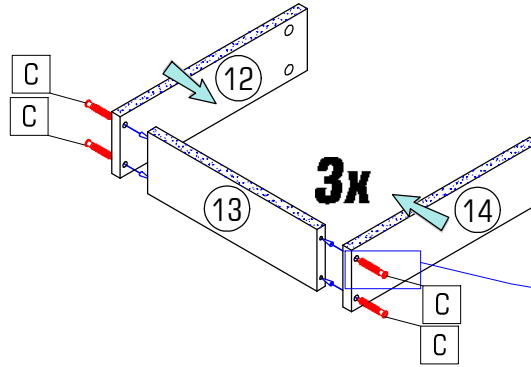
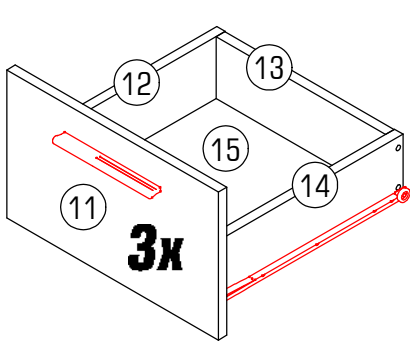
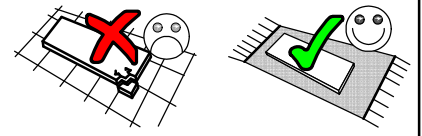
8/10 LASET NEW

A 12x	C 12x	J 9x	P 18x	W2 3x

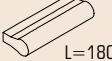

			
Ø3,5x15	Ø4x30	L=180	
P 12x	Q 6x	V 3x	Y1 6x

